

WEINZIERL

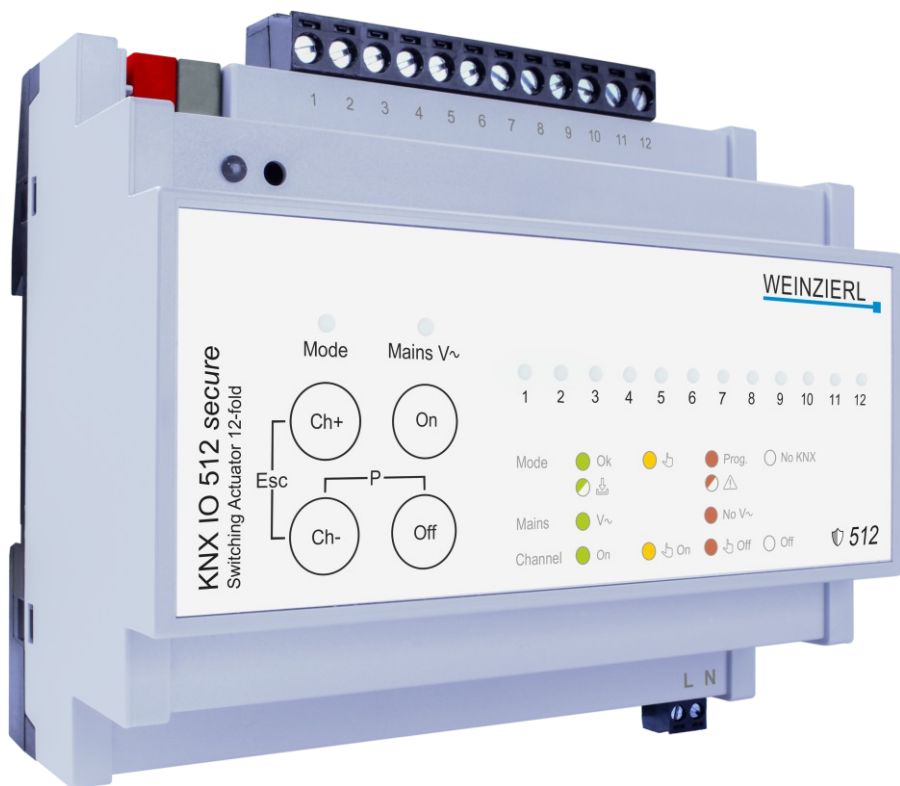

SYSTEM SOLUTIONS FOR THE KNX STANDARD



DMX

MADE
IN
GERMANY

DEVICES 2024

About us

The company

Weinzierl Engineering GmbH develops software and hardware components for building technology. Our focus is on building control based on open technologies such as KNX, Modbus or EnOcean. This ensures the future viability of the products for our customers.

We develop and manufacture complete devices both under our own name and as OEM components.

20 years Weinzierl

Weinzierl has been successfully represented on the market for over 20 years. Over the years, the company has continued to develop. A steadily growing team and the expansion of a second office building are just two facets of this process.

Quality from the beginning

Since our foundation in 2001, Weinzierl has consistently focussed on quality. Quality management in accordance with ISO9001 was introduced in the early years and certified for the first time in 2003. This means that Weinzierl has been continuously certified for more than 20 years.

Made in Germany

With our own production facilities, we focus on local value creation of the highest quality. Our most important suppliers are also located in Germany.

Team

With our team of experienced developers and dedicated employees, we offer extensive knowledge and expertise in intelligent building systems technology.

This enables us to achieve a high level of development depth in hardware, software and mechanics.

Competence

Weinzierl has its own system development, both in the area of KNX stacks and software tools. This development forms the basis for our rapid implementation of new technologies. For example, KNX RF (radio) with full ETS® integration or innovations such as KNX IP only devices.

Portfolio

Weinzierl is known as a manufacturer of KNX interface and gateway solutions, i.e. highly complex system devices.

Our products not only utilise the KNX bus (twisted pair), but also the newer KNX RF and KNX IP media.

We have further expanded our range of KNX actuators and KNX push buttons.

A key feature of all our products is their user-friendliness. We consistently use plug-in terminals and equip complex devices with displays. Our aim is to reduce installation and maintenance costs. Their user-friendliness. We consistently use plug-in terminals and equip complex devices with displays. Our aim is to reduce installation and maintenance costs.

Sustainability

The Weinzierl company consistently focusses on sustainability in its activities. It is important to us to act in an environmentally friendly and resource-saving manner. For example, we largely cover our electricity requirements with PV systems and storage facilities. We consistently avoid plastic in our packaging and minimise the volume of packaging. We also deliberately avoid having a sales force with a high level of travelling.



Open and future-proof

Open standards are essential for cross-manufacturer solutions. The networking of a wide variety of systems requires open technologies.

KNX is the world's most successful standard for controlling modern buildings. However, special solutions such as EnOcean, Modbus or DMX are also supported for individual applications.

First choice

A true global standard: the world of home and building automation "speaks" KNX. Whether smart home or building automation. With its various media, KNX technology offers universal solutions for old and new buildings. KNX was the first global standard for building technology to be certified according to EN and ISO / IEC. As an active member of the KNX Association, we are helping to develop and shape the future of the standard.

Requirements

Whether in a detached house or an office complex, the requirements for comfort and options for controlling air conditioning, lighting and access control are growing. At the same time, the efficient use of energy is becoming increasingly important. This can only be achieved by intelligently connecting and controlling all components.

Security

The security requirements in building automation are increasing.

Laws and standards will also increasingly require the secure transmission of digital information.

Weinzierl recognised this at an early stage and consistently implements encryption. A large proportion of our devices now support KNX IP Security or KNX Data Security.



DMX



Content

2	About us
4	KNX System devices
6	KNX Compact IO
8	KNX Block IO
10	KNX Multi IO
13	KNX Blue IO
15	KNX Gateways: EnOcean
16	KNX IP Interface, Router
18	KNX IP BAOS 777
22	KNX Gateways: Modbus, DMX
24	MATCH 55 push button series
29	KNX RF

Powerful base



Basis of your installation

System devices form the technical basis of every KNX installation. Therefore the quality of the system devices is essential for reliable operation. Since the devices are in operation around the clock, low energy consumption is essential in terms of CO₂ avoidance and green buildings. Our bus power supplies are characterized by high efficiency and at the same time require only 4 units (72 mm) of space.

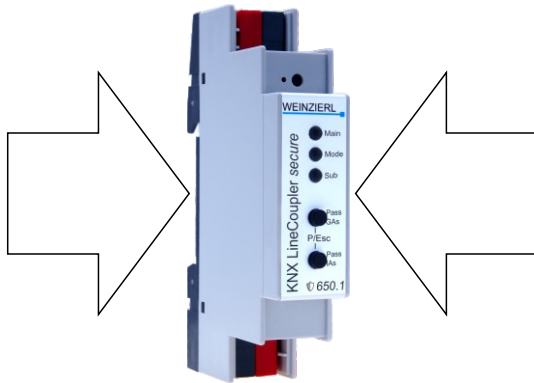

Saving space and costs

Every unit in the switch cabinet is associated with costs, even more so when space is at a premium. The high level of integration of our system devices therefore not only saves space in the switch cabinet, but also costs. With the KNX TP LineCoupler 650.1 *secure*, we offer you a line coupler with only 1 unit (18 mm) with one bus connector each for the main and subline.

Look closer

Diagnostic functions reduce maintenance costs. The system devices from Weinzierl offer various diagnostic functions to quickly locate system errors. For example, both the interface devices and the couplers are able to visualize faulty telegrams or telegram repetitions. The most powerful diagnostic functions are provided by the KNX PowerSupply DGS 366 and KNX PowerSupply USB 367 both via the bus and via the integrated display.



Why a power supply with a display?

This raises the question of whether a power supply actually requires a display. The answer is simple: If everything works perfectly, it can work without, but if the KNX system does not work reliably, the diagnosis via the display provides valuable information for further analysis.

KNX USB Interface 312 - KNX USB interface



Compact USB data interface between a PC or laptop and the KNX bus.
The device can be used as a programming interface for ETS®.

- Support of KNX Long Frames
- Support of Weinzierl BAOS Protocol V2
- Status display via 2 LEDs
- Connections: KNX, USB type B
- For DIN rail, width 1 unit (18 mm)

KNX USB Interface 312

Art. no. 5229 Gross price* 189,60 €

KNX USB Interface Stick 332 - KNX USB interface



Compact USB data interface in stick format between a PC or laptop and the KNX bus.
The stick can be used as a programming interface for ETS®.

- Support of KNX Long Frames
- Support of Weinzierl BAOS Protocol V2
- Status display via 2 LEDs
- Connections: KNX, USB type A
- Dimensions (LxWxH): 58 x 18 x 12 mm
- Delivery in plastic box

KNX USB Interface 332

Art. no. 5254 Gross price* 189,60 €

KNX PowerSupply 365 - KNX power supply 640 mA



Bus power supply with high efficiency and low space requirement.
Integrated bus choke and additional output for auxiliary voltage.

- Output current 640 mA with bus choke
- Status display via 3 LEDs
- Connections: KNX, auxiliary voltage output 30 V_~, plugable screw terminal for 230 V_~
- For DIN rail, width 4 units (72 mm)

KNX PowerSupply 365

Art. no. 5335 Gross price* 234,70 €

KNX PowerSupply DGS 366 - KNX power supply 640 mA with diagnostic



Bus power supply with high efficiency and low space requirements. Comprehensive diagnostic functions.
Integrated bus choke and additional output for auxiliary voltage.

- Output current 640 mA with bus choke
- Graphic display (OLED)
- Integrated KNX node with diagnostic and logic functions
- Connections: KNX, auxiliary voltage output 30 V_~, plugable screw terminal for 230 V_~
- For DIN rail, width 4 units (72 mm)

KNX PowerSupply DGS 366

Art. no. 5207 Gross price* 355,90 €

KNX PowerSupply USB 367 - KNX power supply 640 mA with USB



Bus power supply like model KNX PowerSupply DGS 366, but with additional integrated USB interface.

- Programming interface for ETS®
- Support of KNX Long Frames
- USB connector: Type Micro B

KNX PowerSupply USB 367

Art. no. 5219 Gross price* 399,50 €

KNX LineCoupler 650.1 secure - KNX line coupler



KNX TP/TP line coupler in compact design. It connects two KNX segments (e.g. a KNX line with a KNX area).

- Status display via 3 LEDs
- Extended filter table for main group 0..31
- Galvanic isolation of the lines
- Support of Security Proxy
- Support of Segment Coupler
- Support of KNX Security
- Support of KNX Long Frames
- Connections: KNX main line, KNX subline
- For DIN rail, width 1 unit (18 mm)

KNX LineCoupler 650.1 secure

Art. no. 5451 Gross price* 259,20 €

Switching, blinds and dimming

Easy to install, easy to operate

With the KNX Compact IO series Weinzierl offers universal inputs and outputs for KNX with a striking small width of only 1 unit (18 mm). This granularity offers maximum flexibility especially for small and medium sized installations. All devices have a uniform operating concept with 3 multicoloured LEDs and 2 keys for manual operation. An easy to install design with screw terminals for plugging in and out helps to reduce costs on the construction site. All devices can be configured with the ETS software without plug-ins and are characterized by short download times.

See it in a new light

Light is a decisive factor for comfort and well-being in buildings. Due to the large number of different light sources and customer requirements, dimming is increasingly becoming a challenge. The dimming actuators from the Compact IO series offer optimum solutions for almost all requirements. For lamps with mains voltage as well as for LEDs in low voltage technology. For color control with RGB or color temperature control with Tunable White. All Weinzierl dimming actuators have numerous comfort functions such as snooze light or sequencer.



KNX IO 410 (4I) - Binary input 4-fold for 12..230 V $\sim\sim$ KNX IO 411 (4Ii) - Binary input 4-fold for dry contacts



Compact binary input with 4 channels for controlling lights, shutters, etc.

- Switching, dimming, shutters, scenes, pulse counter
- Integrated logic and timer functions
- Galvanically isolated
- Connections: KNX, pluggable screw terminals for IO
- For DIN rail, width 1 unit (18 mm)

KNX IO 410 (4I): for 12..230 V $\sim\sim$
KNX IO 411 (4Ii): for dry contacts

Art. no. 5230 Gross price* 106.90 €
Art. no. 5231 Gross price* 103.90 €

KNX IO 510.1 secure (2O) - Switch actuator 2-fold



Compact switching actuator with 2 outputs. Functions for universal output, staircase lighting, heating actuator, etc.

- 2 output relays 250 V \sim , 10 A, bistable
- Switching, staircase function, heating actuator
- Integrated logic and timer functions
- Connections: KNX, pluggable screw terminals for IO
- Support of KNX Security
- For DIN rail, width 1 unit (18 mm)

KNX IO 510.1 secure (2O)

Art. no. 5444 Gross price* 112.90 €

KNX IO 511.1 secure (1O2I) - Switch actuator 1-fold and binary input 2-fold



Compact switch actuator with one bistable output and 2 binary inputs. Suitable as KNX compatible replacement for conventional impulse switches (output: light, input 1: pushbutton, input 2: L for zero-crossing detection).

- 1 output relay 230 V \sim , 16 A, bistable
- Switching, staircase function, heating actuator
- 2 inputs 12..230 V $\sim\sim$, galvanically isolated
- Switching, dimming, shutters, scenes, pulse counter
- Zero-crossing detection via input channel
- Integrated logic and timer functions
- Support of KNX Security
- Connections: KNX, pluggable screw terminals for IO
- For DIN rail, width 1 unit (18 mm)

KNX IO 511.1 secure (1O2I)

Art. no. 5327 Gross price* 110.80 €

KNX IO 520 (1J2I) - Blind actuator 1-fold and binary input 2-fold

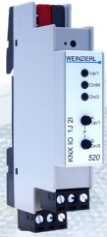

Compact blind/shutter actuator with two additional binary inputs. Numerous functions including position drive via time calculation.

- 1 shutter output, 230 V~, 8 A
- Drive directions electro-mechanically locked against each other
- For blinds, shutters or window drives
- Approach position via time calculation
- 2 inputs 12..230 V~~, galvanically isolated
- Switching, dimming, shutters, scenes, pulse counter
- Integrated logic and timer functions
- Connections: KNX, plugable screw terminals for IO
- For DIN rail, width 1 unit (18 mm)

KNX IO 520 (1J2I)

Art. no. 5225 Gross price* 106.30 €

KNX IO 530 (1D2I) - Universal dimming actuator 1-fold and binary input 2-fold



Compact 230 V universal dimmer with one output and 2 binary inputs. The dimmer supports numerous functions (staircase function, snooze function), as well as phase angle or phase cut-off control.

- Compatible with incandescent lamps, as well as LED retrofit
- Dimmer output for 230 V~ / 200 W
- Scenes, sequencer, staircase function, adjustable dimming curve
- 2 binary inputs for 230 V~ same potential as dimming actuator
- Integrated logic and timer functions
- Connections: KNX, plugable screw terminals for IO
- For DIN rail, width 1 unit (18 mm)

KNX IO 530 (1D2I)

Art. no. 5312 Gross price* 138.90 €

KNX IO 532 (1D1O) - LED dimming actuator 1-fold and switching actuator 1-fold



Compact dimming actuator with one PWM output for dimming LEDs and one relay output. The dimming actuator can be used e.g. for LED panels/strips. The relay output can be used to switch the LED power supply.

- Output for 12..24 V~ / 6 A, PWM dimming actuator
- Scenes, sequencer, staircase function, adjustable dimming curve
- Relay 250 V~ / 10 A, bistable
- Integrated logic and timer functions
- Connections: KNX, plugable screw terminals for IO
- For DIN rail, width 1 unit (18 mm)

KNX IO 532 (1D1O)

Art. no. 5313 Gross price* 137.60 €

KNX IO 534 CV (4D) - LED dimming actuator 4-fold with constant voltage

KNX IO 536 CC (4D) - LED dimming actuator 4-fold with constant current



Compact 4-fold dimming actuator with RGB, RGBW and Tunable White (TW) functions. The dimming actuator can be used e.g. for LED panels/strips with RGB / RGBW / Tunable White or for 4 independent dimming channels.

- 12..24 V~ / Max. load current: 6 A total, freely distributable PWM dimming actuator (for CV)
- 12..48 V~ / Max. configurable load current: 500 mA each channel (channels can be bundled) (for CC)
- Scenes, sequencer, staircase function, adjustable dimming curve
- Integrated logic and timer functions
- Connections: KNX, plugable screw terminals for IO
- For DIN rail, width 1 unit (18 mm)

KNX IO 534 CV (4D): Constant voltage

KNX IO 536 CC (4D): Constant current

Art. no. 5314 Gross price* 159.80 €

Art. no. 5354 Gross price* 162.30 €

KNX IO 546.1 secure (1D1O) - 1..10 V dimming actuator 1-fold and switching actuator 1-fold



Compact dimming/switching actuator with one dimming channel for the connection of active electronic ballasts (ECG) with a 0/1..10 V~ interface and one relay output. The relay output can be used for switching the load.

- Output for 0/1..10 V~ / max. 50 mA
- Scenes, sequencer, staircase function, adjustable dimming curve
- Relay 250 V~ / 10 A, bistable
- Integrated logic and timer functions
- Also compatible with 0..10 V~ actuators (valves)
- Connections: KNX, plugable screw terminals for IO
- For DIN rail, width 1 unit (18 mm)
- Support of KNX Security

KNX IO 546.1 secure (1D1O)

Art. no. 5337 Gross price* 121.40 €

KNX actuators en bloc

KNX Block IO: Reliable and safe

KNX Block IO is a new platform for KNX actuators from Weinzierl. It offers a high channel density while consistently focussing on reliability and security. Support for KNX security is a matter of course.

Central power supply with mains monitoring

The new platform is characterised by a central feed for all channels. This enables quick and clear wiring in the control cabinet and monitoring of the mains voltage. A mains failure is indicated by an LED on the device and can also be signalled with a group telegram on the bus.

Manual operation with multiple selection, even without bus

The devices allow multiple selection for manual operation. This allows several channels to be switched simultaneously. Manual operation is also possible without bus voltage.

KNX IO 512 *secure* - Switching Actuator 12-fold

The KNX switching actuator KNX IO 512 *secure* offers 12 bistable relay outputs that are primarily optimised for the requirements of LED lights. However, the outputs can also be used for other loads. The application also supports the control of thermal valve drives.

16 A input current, 12x 16 A output current

What sounds like a contradiction is actually a balanced dimensioning, especially for LED lighting. LED lights are characterised by their relatively low power consumption. The power consumption of typical residential luminaires is usually well below 100 W. At the same time, LED luminaires have a very high input current due to their capacitive input characteristics. This is why the individual switching channels, including the relays, are dimensioned for a switching capacity of 16 A.

Switching at zero crossing

To avoid particularly high inrush currents, the KNX IO 512 *secure* can set the switching point to the zero crossing of the mains voltage when switching on. This not only avoids very high current surges in the installation, but also significantly extends the service life of the relays.

Direct switching with the ETS

In addition to manual operation on the device, the new series also enables direct control of the channels from the parameter area of the ETS. This means that all channels can be switched on and off individually or all at the same time. Only the physical address of the device needs to be programmed for this. No parameter settings or group addresses are required. This makes it possible to switch the outputs directly with the ETS - even in remote maintenance.

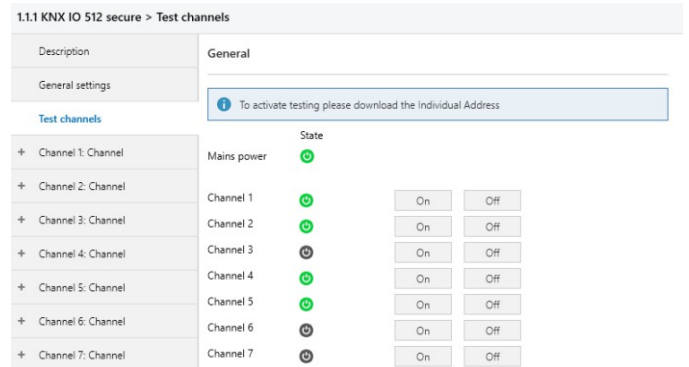

Offset switching

Another function for avoiding current peaks is the offset switching of central commands. If several channels are switched on at the same time, a time offset can be set between the channels. This function is also effective when restoring the power supply after a power failure. The parameters enable load shedding in the event of a power failure and delayed switch-on on recovery. This also prevents possible tripping of the line protection (fuse), which can occur when up to 12 LED lights are switched on at the same time.

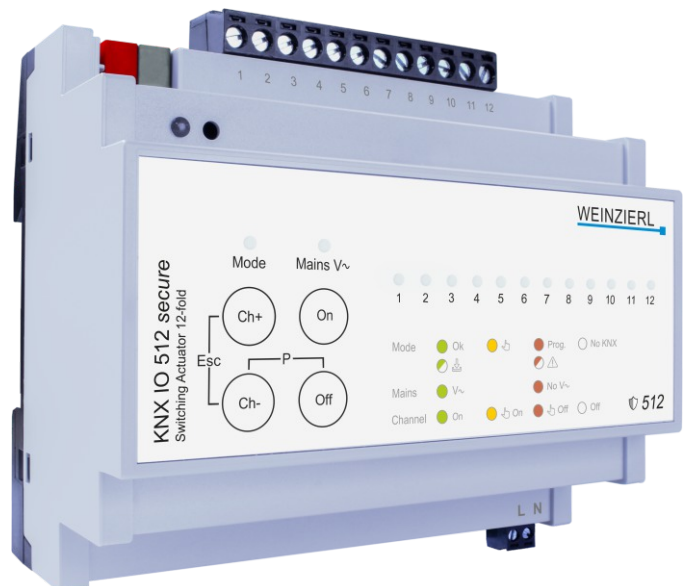

KNX IO 512 *secure* - Switching actuator 12-fold



Compact KNX switching actuator with central power supply and 12 outputs. Functions for universal output, staircase lighting, heating actuator, etc. Optimised for LED lights.

- 12 outputs relay 230 V~, 16 A, bistable
- Switching, staircase function, heating actuator
- Integrated logic and time functions
- Mains failure detection with comm. object
- Switching in zero crossing
- Time-delayed switching with central commands
- Manual operation without bus voltage
- Manual operation via ETS
- Support of KNX Security
- Connections: KNX, plug-in screw terminals for IO
- For DIN rail, width 6 units (108 mm)

KNX IO 512 *secure* (Switching actuator 12-fold)

Art. no. 5491 Gross price* 368.60 €

KNX IO 522 *secure* - Shutter actuator 6-fold



Compact KNX shutter actuator with central power supply and 6 outputs. Position movement via time calculation.

- 6 channels for electric drives, 230 V~, 16 A
- For blinds, shutters or window drives
- Drive directions electro-mechanically interlocked against each other
- Integrated logic and time functions
- Mains failure detection with comm. object
- Manual operation without bus voltage
- Manual operation via ETS
- Support of KNX Security
- Connections: KNX, plug-in screw terminals for IO
- For DIN rail, width 6 units (108 mm)

KNX IO 522 *secure* (Shutter actuator 6-fold)

Art. no. 5496 Gross price* 368.60 €

KNX IO 522 *secure* - Shutter Actuator 6-fold

The KNX shutter actuator KNX IO 522 *secure* offers 6 channels for controlling blinds, shutters or other drives with mains voltage. The outputs per channel are electro-mechanically interlocked to prevent double current flow. The device also offers extensive functions for optimised control of blinds, shutters or window openers. Positions can be approached with time calculation.

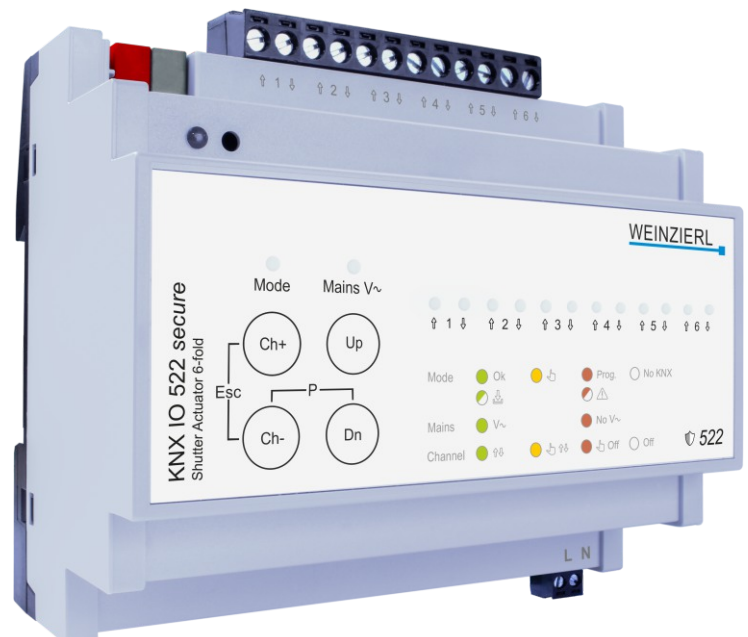

IO innovations

KNX Multi IO: Multiple flexibility

The KNX Multi IO devices 570 and 580 series, with their 48 channels, offer maximum flexibility for inputs and outputs. The devices work with an external auxiliary voltage of 24 V $\overline{\text{=}}$, the channels can be configured individually with the ETS:

Binary input

- For connecting potential free contacts
- Application for switching, dimming, blinds, etc.
- Evaluation of window contacts

Switching output

- For the control of signal LEDs
- Switching of 230 V \sim loads with standard coupling relays or with Weinzierl Multi IO Extension Switch 590

Blind output

- Control for 230 V \sim electric drives with Weinzierl Multi IO Extension Shutter 592
- One channel can control both directions

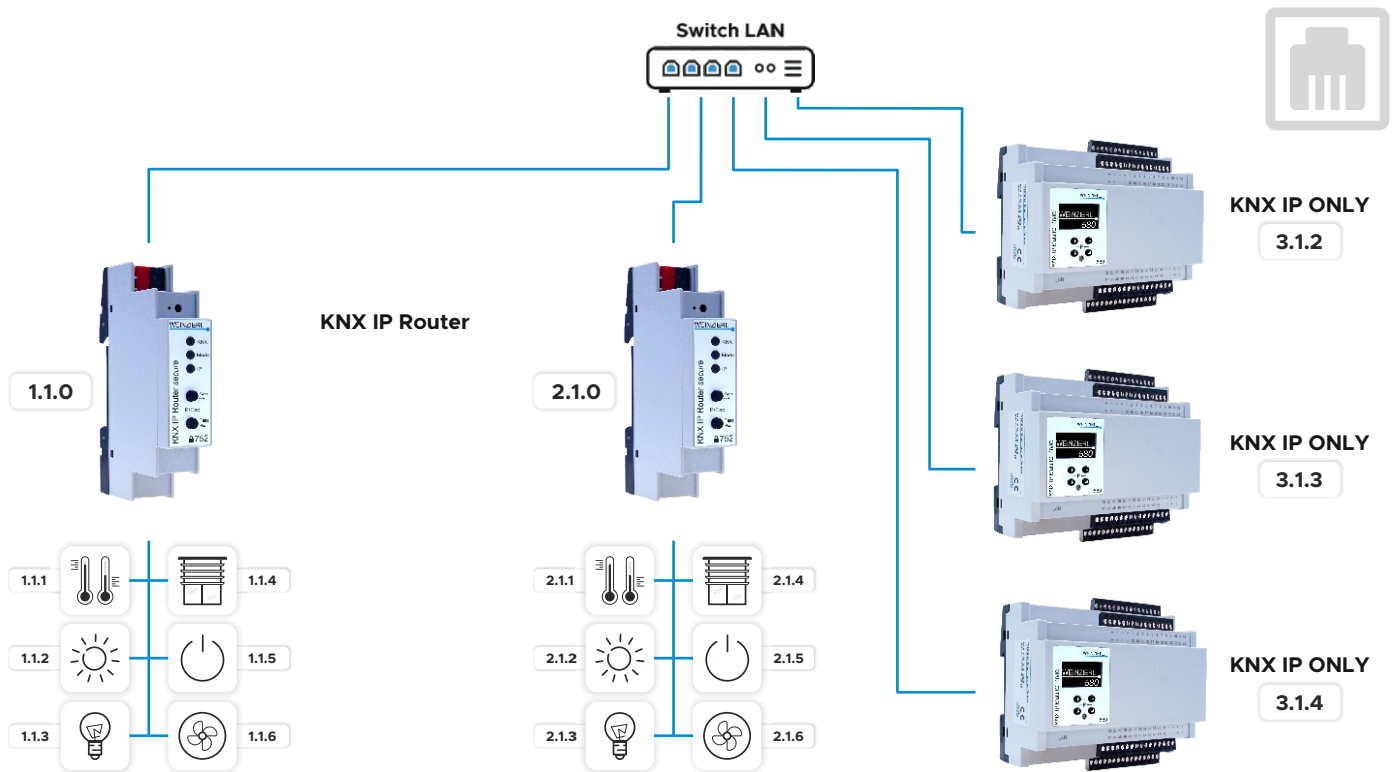

Completely based on IP

The KNX IP Multi IO 580 offers similar features as the TP version KNX TP Multi IO 570 and is the first purely IP based KNX device (KNX IP only) from Weinzierl. It combines the power of KNX with the advantages of IP/Ethernet technology. The device will be connected over LAN/Ethernet. The connection to the KNX TP bus is done via a KNX IP router. Though no KNX TP bus is connected, KNX IP only devices are fully fledged KNX devices. They can be configured using ETS software with native parameters and standard group objects. Also the KNX addressing scheme, based on individual device address and group objects, is unchanged. Only the IP settings have to be taken in account. The ETS download is done via the IP network. If the ETS is connected via IP the download is very fast and requires not more than a few seconds.

KNX TP Multi IO 570 (48I/O) - KNX input and output module 48-fold



Universal input and output module for building control. The device offers 48 digital channels. Each channel can be used as a binary input, binary output or shutter output. Input channels can be used to connect push buttons. Output channels can directly control signal LEDs, external coupling relays or shutter relays. The peripheral devices (e.g. relays) are supplied by an external power supply (24 V_{DC}).

- Flexible configuration of the channels as binary inputs, outputs or shutter outputs
- OLED display and buttons for manual operation
- Integrated USB interface for programming with ETS®
- Support of KNX Long Frames
- Output current max. 100 mA per channel
- Connections: KNX, USB type Micro B, plugable screw terminals for 24 V_{DC} (input), plugable screw terminals for IO
- For DIN rail, width 4 units (72 mm)

KNX TP Multi IO 570 (48I/O)

Art. no. 5267 Gross price* 429.80 €

KNX IP Multi IO 580 (48I/O) - KNX input and output module 48-fold for IP



Universal input and output module for building control for KNX IP. The device works with the medium KNX IP and is connected to the KNX installation via LAN/Ethernet. The device provides 48 digital channels. Each channel can be used as binary input, binary output or shutter output. Input channels can be used to connect push buttons. Output channels can directly control signal LEDs, external coupling relays or shutter relays. The peripheral devices (e.g. relays) are supplied by an external power supply (24 V_{DC}).

- Flexible configuration of the channels as binary inputs, outputs or shutter outputs
- OLED display and buttons for manual operation
- Output current max. 100 mA per channel
- Connections: LAN RJ-45 (KNX IP), plugable screw terminals for 24 V_{DC} (input), plugable screw terminals for IO
- For DIN rail, width 6 units (108 mm)

KNX IP Multi IO 580 (48I/O)

Art. no. 5238 Gross price* 498.80 €

Modularity saves costs

The devices in the Weinzierl Multi IO series are inspired by industrial automation. In plant engineering, it is common practice to separate the relays from the control electronics (e.g. PLC). This modular device approach - the separation of the wear-free control unit and the output relays - reduces maintenance costs. The failure of individual relays can be rectified without tools and without an ETS download, without affecting the rest of the installation.

Display for diagnostic purposes

The menu system on the display enables quick diagnostics and local operation. The display shows the name of the device as well as the names of the individual channels and their function according to the settings in the ETS parameters. The buttons on the front of the device allow manual control of the outputs.

Fast download via USB or IP

The USB interface of the KNX TP Multi IO 570 serves as a programming interface for the ETS to load devices on the KNX bus. However, it also offers a local and fast download to the device itself. The KNX IP Multi IO 580 offers a fast download via the direct network connection.



Extensions for KNX Multi IO

Multi IO Extension Switch 590 - Coupling relay for Multi IO



The relay extension serves as a power-saving alternative for commercially available coupling relays for operation with art. no. 5267, 5238. Bistable relay internal, external control like monostable relay.

- Reduction of the holding current by up to 95 %
- Input (signal) 24 V= / Output 230 V~ / 10 A
- Pluggable relay 250 V~ / 16 A, bistable
- Integrated fuse (5 x 20 mm) to protect high-value devices
- Connections: Screw terminals for IO
- For DIN rail, width 1 unit (18 mm)

Multi IO Extension Switch 590

Art. no. 5321 Gross price* 39.40 €

Replacement and spare relays - Coupling relays for Multi IO



Spare relay for Multi IO Extension Switch 590 with art. no. 5321.

- Spare relay:** Standard
- Spare relay:** with tungsten precontact
- Spare relay:** with manual operation

10 pcs	Art. no. 5347	Gross price*	52.30 €
10 pcs	Art. no. 5348	Gross price*	78.20 €
10 pcs	Art. no. 5349	Gross price*	75.40 €

Multi IO Extension Shutter 592 - Shutter relay for Multi IO



Double relay especially for the control of blinds and shutters. The double relay is connected to only one output of a KNX Multi IO. Directional control of the relay outputs is achieved by coding the input voltage. For operation with art. no. 5267, 5238.

- Direction control by the output signal of the KNX Multi IO
- Outputs electro-mechanically locked against each other
- Input (signal) 24 V= / Output 230 V~ / 6 A
- Pluggable relay 250 V~ / 6 A
- Integrated fuse (5 x 20 mm) to protect high-value devices
- Connections: Screw terminals for IO
- For DIN rail, width 1 unit (18 mm)

Multi IO Extension Shutter 592

Art. no. 5322 Gross price* 49.40 €

Replacement and spare relays - Shutter relay for Multi IO



Spare relay for Multi IO Extension Shutter 592 with art. no. 5322.

Spare relays: Standard

10 pcs Art. no. 5346 Gross price* 44.90 €

Standard coupling relay - Coupling relay for Multi IO



Standard coupling relay for operation with art. no. 5267, 5238.

- Extension of the KNX multi series, switching function
- Input (signal) 24 V= / Output 230 V~ / 10 A
- Pluggable Relay 250 V~ / 16 A, monostable
- Connections: Screw terminals for IO
- For DIN rail, width 1 unit (18 mm)

Standard coupling relay

10 pcs Art. no. 5350 Gross price* 124.90 €

Replacement and spare relays - Coupling relays for Multi IO



Spare relay for standard coupling relay with art. no. 5350.

Spare relay: Standard

10 pcs Art. no. 5351 Gross price* 44.90 €

Dimming the new way

Get your lights connected

The Weinzierl dimmer family has been expanded by 4 devices with the new KNX Blue IO 55x product range. The flat design is optimized to be mounted in furniture or ceilings. All devices of the new series offer four dimming outputs for low voltage LEDs with functions for RGB/RGBW and TW (Tuneable White). Each model is available in variants for constant voltage (CV) as well as for constant current (CC). The used dimming mode (constant voltage or constant current) has to fit with the used LED lighting equipment.



Constant Voltage (CV)

The main advantage of using a constant voltage is its simplicity. The dimming of the constant voltage is based on PWM (pulse width modulation), the pulse width represents the brightness of the output. A wide range of LED lamps and LED strips designed for constant voltage dimming is available on the market. This ensures a high degree of compatibility. The components can be operated with a constant voltage of 12 V to 24 V. In constant voltage mode, the current limitation required for all LED components is realised within the lamps or strips, typically only via simple resistors.



KNX Security

For RF and IP communication, secure communication is essential for user acceptance. But even with twisted pair, security helps to protect the infrastructure, e.g. in public buildings or hotels. All devices in the KNX Blue IO series support KNX Security.

Constant Current (CC)

LED lamps and strips for constant current do not contain an internal current limiter. Instead, these devices specify a nominal current that must be provided by the connected power supply or the dimming actuator. As an advantage, the current limitation can be realised with highly efficient electronic circuits instead of simple resistors. Constant current operation therefore results in a significantly lower power loss. In constant current mode, the output current can be controlled for dimming. As there is no PWM at the output, the dimming behaviour is flicker-free. LED lamps for constant current are commercially available with typical values of e.g. 350 mA, 700 mA or 1000 mA.

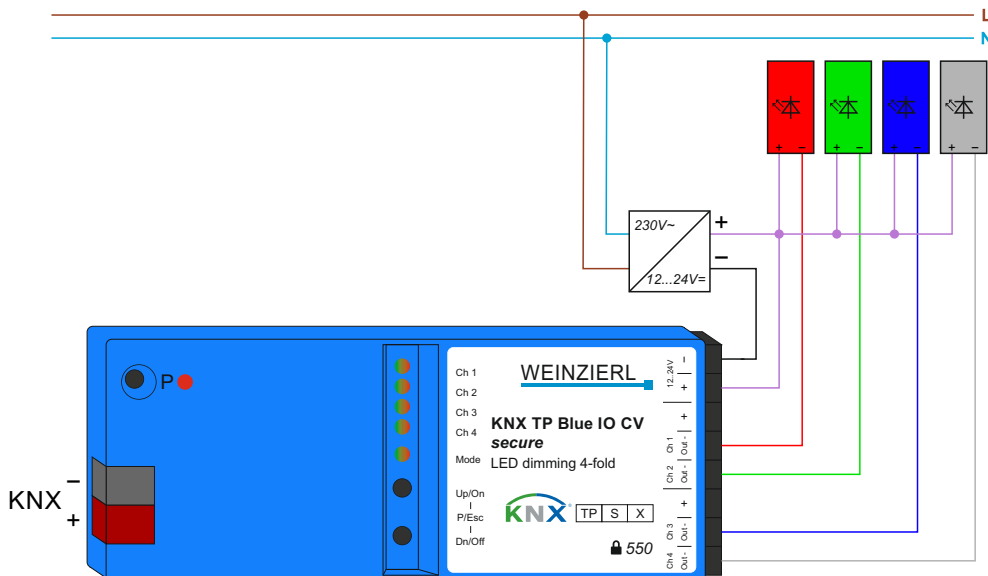

KNX Blue IO

KNX TP Blue IO 550 CV *secure* - LED dimming actuator 4-fold with constant voltage

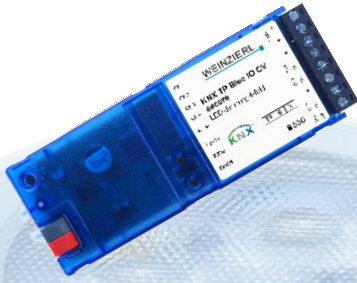

KNX TP 4-fold LED dimming actuator.

- 12..24 V $\overline{\text{=}}$ / Max. load current: 6 A total, freely distributable PWM dimming actuator (for CV)
- RGB, RGBW, Tunable White
- Scene support, sequencer, staircase function, adjustable dimming curve
- Integrated logic and time functions
- Support of KNX Security
- Connectors: KNX, plugable screw connectors for IO
- Size (LxWxH): 132 x 46 x 20 mm

KNX TP Blue IO 550 CV *secure*: Constant voltage

Art.-Nr. 5377 Gross price* 159,80 €

KNX TP Blue IO 551 CC *secure* - LED dimming actuator 4-fold with constant current



KNX TP 4-fold LED dimming actuator.

- 12..48 V $\overline{\text{=}}$ / Max. configurable load current: 500 mA each channel (channels can be bundled) (for CC)
- RGB, RGBW, Tunable White
- Scene support, sequencer, staircase function, adjustable dimming curve
- Integrated logic and time functions
- Support of KNX Security
- Connectors: KNX, plugable screw connectors for IO
- Size (LxWxH): 132 x 46 x 20 mm

KNX TP Blue IO 551 CC *secure*: Constant current

Art.-Nr. 5378 Gross price* 162,30 €

KNX RF Blue IO 552 CV *secure* - LED dimming actuator 4-fold with constant voltage for RF

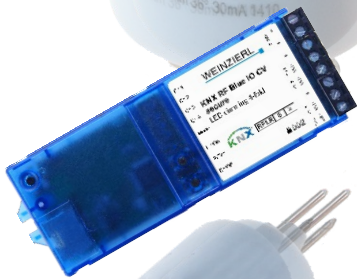

KNX RF (wireless) 4-fold LED dimming actuator.

- 12..24 V $\overline{\text{=}}$ / Max. load current: 6 A total, freely distributable PWM dimming actuator (for CV)
- RGB, RGBW, Tunable White
- Scene support, sequencer, staircase function, adjustable dimming curve
- Integrated logic and time functions
- Support of KNX Security
- Connectors: Plugable screw connectors for IO
- Size (LxWxH): 132 x 46 x 20 mm

KNX RF Blue IO 552 CV *secure*: Constant voltage

Art.-Nr. 5379 Gross price* 159,80 €

KNX RF Blue IO 553 CC *secure* - LED dimming actuator 4-fold with constant current for RF



KNX RF (wireless) 4-fold LED dimming actuator.

- 12..48 V $\overline{\text{=}}$ / Max. configurable load current: 500 mA each channel (channels can be bundled) (for CC)
- RGB, RGBW, Tunable White
- Scene support, sequencer, staircase function, adjustable dimming curve
- Integrated logic and time functions
- Support of KNX Security
- Connectors: Plugable screw connectors for IO
- Size (LxWxH): 132 x 46 x 20 mm

KNX RF Blue IO 553 CC *secure*: Constant current

Art.-Nr. 5380 Gross price* 162,30 €

General features

All KNX Blue IO devices feature support for scenes, sequencer, staircase function and allow the setting of dimming curves. To simplify configuration and maintenance, the devices share a uniform operating concept based on 5 multicolor LEDs and 2 push buttons. The load is connected via plugable screw connectors.

KNX Gateways: EnOcean

KNX and EnOcean

For many applications, the technology of EnOcean is interesting for building automation: the system is characterized mainly by battery-free wireless sensors. The devices of the KNX ENO series serve as efficient gateways between EnOcean radio and the KNX bus. The ultra-compact KNX ENO 626 disappears almost invisibly in a commercially available concealed housing. The KNX ENO 636 features a graphical display and a stylish housing and offers convenient diagnostic functions. The devices are based on the EnOcean Equipment Profiles (EEP). This guarantees compatibility with countless EnOcean products of any manufacturer. In addition, the gateways provide logic and control functions and include a radio repeater.



KNX ENO 626 *secure* - KNX gateway to EnOcean 8-fold

Bidirectional, compact gateway between EnOcean and the KNX bus. The device supports encrypted radio communication with EnOcean Secure devices. Over 100 device profiles (EEP EnOcean Equipment Profiles) enable simple and secure connection of various EnOcean sensors and actuators to KNX installations.



- 8 channels for sensors, actuators or logic + 8 channels for logic only
- Integrated logic and control functions
- Support of EnOcean Security
- Support for over 100 profiles (EEP)
- Connections: KNX, internal antenna
- Compact flush mounted housing
- Dimensions (LxWxH): 48 x 40 x 18 mm

KNX ENO 626 *secure*

Art. no. 5269 Gross price* 249.90 €

KNX ENO 636 *secure* - KNX gateway to EnOcean 32-fold

Bidirectional gateway between EnOcean and the KNX bus. The device supports encrypted radio communication with EnOcean Secure devices. More than 100 device profiles (EEP EnOcean Equipment Profiles) allow an easy and secure connection of different EnOcean sensors and actuators to KNX installations.



- 32 channels for sensors, actuators or logic
- Integrated logic and control functions
- Support of EnOcean Security
- Support for over 100 profiles (EEP)
- Integrated graphic display
- Connections: KNX, internal antenna
- Housing for surface mounting, white
- Dimensions (LxWxH): 81 x 81 x 25 mm

KNX ENO 636 *secure*

Art. no. 5268 Gross price* 428.40 €

KNX RF / ENO Push Button 440 *secure* with single rocker - KNX push button MATCH 55 series KNX RF / ENO Push Button 440 *secure* with double rocker - KNX push button MATCH 55 series

KNX wireless push button of the MATCH 55 series, with integrated bus coupling unit. The wireless push button offers support for EnOcean and KNX RF in one device. The device works in EnOcean mode without configuration (EnOcean Security is activated by a simple push button combination). By configuration with ETS® the push button switches to KNX RF mode and offers optional support of KNX Security.

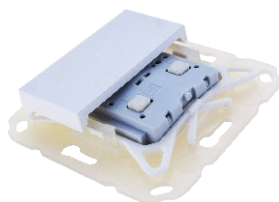

- Pleasantly soft and quiet pressure point
- EnOcean 868.3 MHz, ASK, EEP F6-02-01 / -03
- Support of EnOcean Security
- KNX RF 868.3 MHz, FSK, S-Mode
- Support of KNX Security
- Powerful KNX application for switching, dimming and shutters
- Functions for scenes, sequences and RGB control
- Integrated interface USB to KNX RF
- Mounting kit included (without design frame)
- Connectors: USB Type Micro B, internal antenna
- Power supply via battery type CR2032
- Rockers for standard frames with internal dimensions 55 x 55 mm
- Dimensions wall mounting plate: 71 x 71 mm, for flush mounted box 68 mm

KNX RF / ENO Push Button 440 *secure*: Single rocker
KNX RF / ENO Push Button 440 *secure*: Double rocker

Art. no. 5374 Gross price* 99.10 €
Art. no. 5326 Gross price* 104.90 €

Intelligent protocol

IP and KNX

While KNX has established itself as the most important standard in building automation, Ethernet has developed into a universal communication solution also for automation tasks. Due to the different system properties, KNX and Ethernet can complement each other perfectly. The decisive advantages of Ethernet lie in its high bandwidth at relatively low system costs and in its enormous spread.



Logical architecture

For modern buildings this results in a hierarchical architecture of building networking: KNX twisted pair and radio for the distributed sensors and actuators, Ethernet IP as a fast backbone and for interfaces to the PC or laptop.

The KNX specification has set a standard for these requirements:

- KNXnet/IP Tunneling: PC access via a LAN connection
- KNXnet/IP Routing: Connection of different KNX lines via IP

KNX IP Security

In building automation, secure communication is becoming more and more of a requirement. The KNX standard specifies a sophisticated solution for KNX Security. It is based on today's technologies like AES and meanwhile fully integrated in ETS software. KNX IP Security encrypts KNX IP communication while communication on KNX TP remains unencrypted. The main advantage of this approach is that the existing KNX TP devices and installations can continue to be used unchanged.

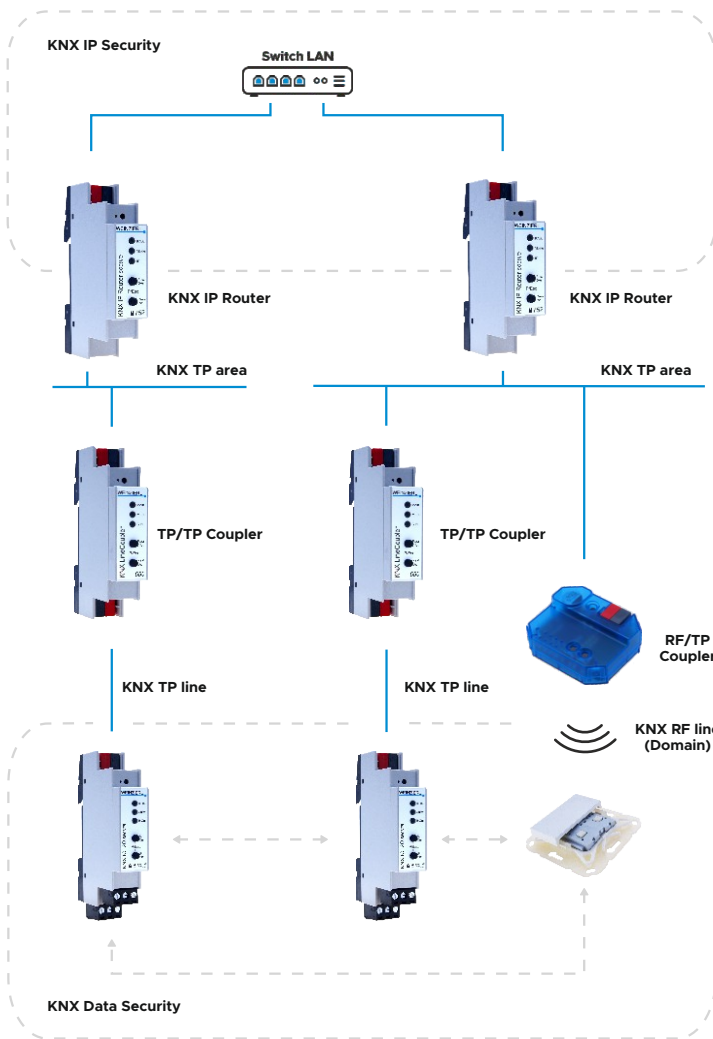

Turn on Security

KNX Security enables the secure forwarding (routing) of telegrams between different lines via a LAN (IP, Ethernet) as a fast backbone. As a secure router, the device enables the coupling of unsecured communication on a KNX TP line with a secure IP backbone. With IP interfaces to the bus (tunneling), KNX IP Security prevents unauthorized access to the system. The connection between PC and interface is encrypted. The encryption also enables secure programming via the Internet. The security option can be activated or deactivated in the ETS.



KNX IP Interface, Router

KNX IP Interface 731 - KNX IP interface

KNX IP Interface 732 *secure* - KNX IP interface with KNX Security



Compact programming interface for connecting one or more PCs to the KNX bus (e.g. for ETS®). Support of KNX IP Security. Connection is made via a LAN interface (IP). Power is supplied via the KNX bus.

- KNXnet/IP tunneling, 8 tunnel connections
- Support of KNX Security
- Support of KNX Long Frames
- Status display via 3 LEDs
- Power supply via KNX bus
- Connections: KNX, LAN RJ-45
- For DIN rail, width 1 unit (18 mm)

KNX IP Interface 731

- KNXnet/IP tunneling, 5 tunnel connections
- No support of KNX Security

KNX IP Interface 731

KNX IP Interface 732 *secure*

Art. no. 5242	Gross price*	211.90 €
Art. no. 5248	Gross price*	215.90 €

KNX IP Interface 740.1 *wireless* - KNX IP interface wireless



Wireless programming interface for connecting a PC or laptop to the KNX bus (e.g. for the ETS®).

The device has an integrated WIFI access point to which the laptop can connect. Alternatively, the device can be connected to an existing WIFI in client mode, the connection can be made via WPS. Power is supplied via the KNX bus.

- KNXnet/IP tunneling
- Support of KNX Long Frames
- WIFI IEEE 802.11b/g/n, encryption WPA2
- Status display via 3 LEDs
- Power supply via KNX bus
- Connections: KNX, antenna
- Dimensions without antenna (LxWxH): 125 x 67 x 31 mm

KNX IP Interface 740.1 *wireless*

Art. no. 5419	Gross price*	376.50 €
---------------	--------------	----------

KNX IP Router 751 - KNX IP router

KNX IP Router 752 *secure* - KNX IP router with KNX Security



Compact IP router for forwarding telegrams between different lines via a LAN (IP) as a fast backbone. Support of KNX IP Security. The device also serves as a programming interface between one or more PCs and the KNX bus (e.g. for the ETS®).

- KNXnet/IP routing
- KNXnet/IP tunneling, 8 tunnel connections
- Support of KNX Security
- Support of KNX Long Frames
- Extended filter table for main group 0..31
- Buffer for 150 telegrams
- Status display via 3 LEDs
- Power supply via KNX bus
- Connections: KNX, LAN RJ-45
- For DIN rail, width 1 unit (18 mm)

KNX IP Router 751

- KNXnet/IP tunneling, 5 tunnel connections
- No support of KNX Security

KNX IP Router 751

KNX IP Router 752 *secure*

Art. no. 5243	Gross price*	358.00 €
Art. no. 5249	Gross price*	364.90 €

KNX IP LineMaster 762.1 *secure* - KNX power supply 640 mA with IP router



The device combines the central functions of a KNX bus line: Bus power supply with bus choke, KNX IP router and KNX IP interface with low space requirement. Comprehensive diagnostic functions. The KNX IP router in the LineMaster enables the forwarding of telegrams between different lines via a LAN (IP) as a fast backbone. The device also serves as a programming interface between a PC and the KNX bus (e.g. for the ETS®).

- Output current 640 mA with bus choke
- KNXnet/IP routing
- KNXnet/IP tunneling, 8 tunneling connections
- Support of KNX Long Frames
- Support of KNX Security
- Graphic display (OLED)
- Extended filter table for main group 0..31, Buffer for 150 telegrams
- Connections: KNX, auxiliary voltage 30 V_{DC}, LAN RJ-45, plugable screw terminals for 230 V~.
- For DIN rail, width 6 units (108 mm)

KNX IP LineMaster 762.1 *secure*

Art. no. 5465	Gross price*	551.70 €
---------------	--------------	----------

Connecting worlds

KNX IP BAOS 774.1 *secure*

The KNX IP BAOS 774.1 *secure* offers KNXnet/IP tunneling (for ETS) with up to 8 connections and a BAOS Object Server with up to 10 connections at a width of just 18 mm. The low-power design allows a power supply via the KNX bus. For getting started, a generic database with 1000 data points is available as well as a DCA (Device Configuration App for ETS) with csv-file import and export. With the KNX MT (manufacturer tool) individual ETS product data bank entries can be created. KNX IP BAOS 774.1 *secure* supports KNX Security.



KNX IP BAOS

From the telegram to the data point: While standard KNX IP interfaces and KNX IP routers work exclusively at the telegram level, the devices of the KNX IP BAOS series also provide access to data point level. As a result, non-KNX devices can be fully integrated into the KNX system. The links to other KNX devices are made with the ETS software. This guarantees the consistency of all KNX addresses used in the system. The BAOS architecture is also an optimal platform for integrating mobile devices.

KNX IP BAOS 773 - KNX IP interface with object server, 250 data points KNX IP BAOS 774 - KNX IP interface with object server, 1000 data points



KNX IP interface to the KNX bus, both on telegram level (KNXnet/IP tunneling) and on data point level (KNX application layer). Thus clients can access the group objects directly via TCP/IP or UDP/IP using a binary protocol. Java Script Object Notation (JSON) is available as an alternative protocol for use in web browsers.

- BAOS Binary V2 & JSON web services
- KNXnet/IP tunneling, 5 tunnel connections
- 10 BAOS connections
- Status displays via 3 LEDs
- Power supply via KNX bus
- Connections: KNX, LAN RJ-45
- For DIN rail, width 1 unit (18 mm)

KNX IP BAOS 773: 250 data points
KNX IP BAOS 774: 1000 data points

Art. no. 5262 Gross price* 303.80 €
Art. no. 5263 Gross price* 361.90 €

KNX IP BAOS 774.1 secure - KNX IP Interface with object server, 1000 data points and security



KNX IP interface to the KNX bus, both at telegram level (KNXnet/IP tunnelling) and at data point level (KNX application layer). This allows clients to access group objects directly via TCP/IP using a binary protocol. The device supports KNX Security and BAOS Security.

- BAOS Binary Protocol V2 with security
- KNXnet/IP tunnelling, 8 tunnel connections
- 10 BAOS connections
- Status displays via 3 LEDs
- Power supply via KNX bus
- Connections: KNX, LAN RJ-45
- For DIN rail, width 1 TE (18 mm)

KNX IP BAOS 774.1 secure

Art. nr. 5475 Gross price* 361.90 €

KNX IP BAOS 777 - KNX IP universal interface with web server and visualization



Universal KNX IP interface with integrated web server and visualization. Convenient operation of the building installation via the web browser of a PC or mobile device.

- Integrated web server with visualization
- Configuration of the visualization with ETS
- E-Mail, NTP, timer and history function
- BAOS protocol incl. RESTful API
- Power over Ethernet (PoE)
- KNXnet/IP tunneling, 8 tunnel connections
- 10 BAOS connections
- Graphic display (OLED)
- Connections: KNX, LAN RJ-45, 12-30 V=
- For DIN rail, width 2 units (36 mm)

KNX IP BAOS 777

Art. no. 5193 Gross price* 464.80 €

KNX Serial BAOS 870 - Serial interface to KNX



Serial interface to the KNX bus with RS-232.

- Telegram format FT1.2 (PE1 10, EMI2)
- Object server with 250 data points
- BAOS binary V2
- Galvanically isolated
- Connections: KNX, RS-232 (Sub-D, fem.)
- For DIN rail, width 1 unit (18 mm)

KNX Serial BAOS 870

Art. no. 5122 Gross price* 198.60 €

KNX BAOS Module 838 kBerry - Extension module for Raspberry Pi



KNX module with serial protocol as expansion card for Raspberry Pi.

- 1000 data points
- Dimensions (LxW): 56 x 35 mm
- Free BAOS SDK for Raspian (see www.weinzierl.de)

KNX BAOS Module 838 kBerry

Art. no. 5208 Gross price* 72.40 €

KNX IP BAOS 777

Integrated webserver and visualization

The KNX IP BAOS 777 is the most powerful platform of our BAOS series. It features a built-in web server for simple visualization via a web browser running on a PC or mobile device. The configuration can easily be done via ETS parameters only - no extra setup or software tool is necessary.



Data logging

The KNX IP BAOS 777 has an integrated data logger that can be activated for each configured data point. An OLED display and 4 push buttons allow quick information retrieval and settings directly on the device.

E-mail services

The integrated e-mail functionality allows the easy setup of push notifications for individually selected functions and data points.

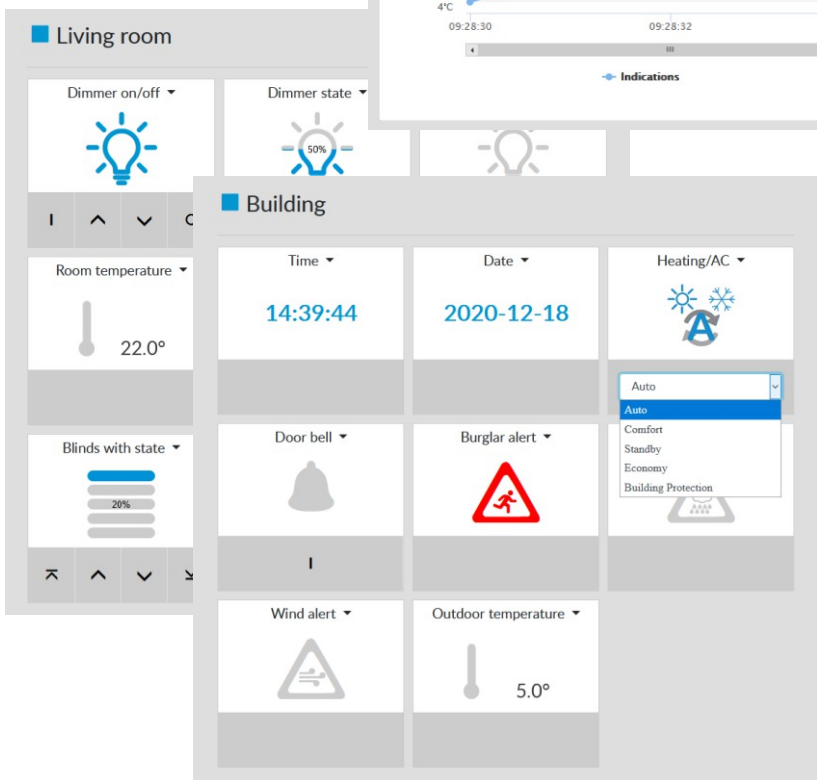
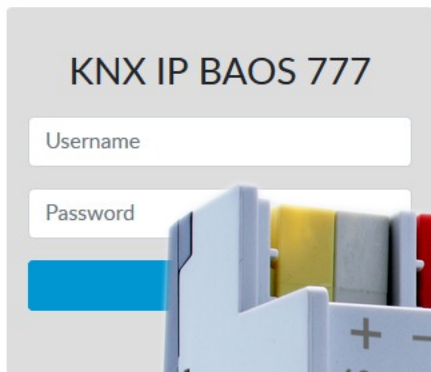

Date and time (NTP)

The integration of an NTP (Network Time Protocol) server makes it possible to obtain the date and time automatically via the Internet and to synchronize the own KNX installation.

Timer

The extensive timer functions can be configured comfortably in the web interface. Cyclic and one-time timers are available, with which e.g. presence simulations can be easily realized.

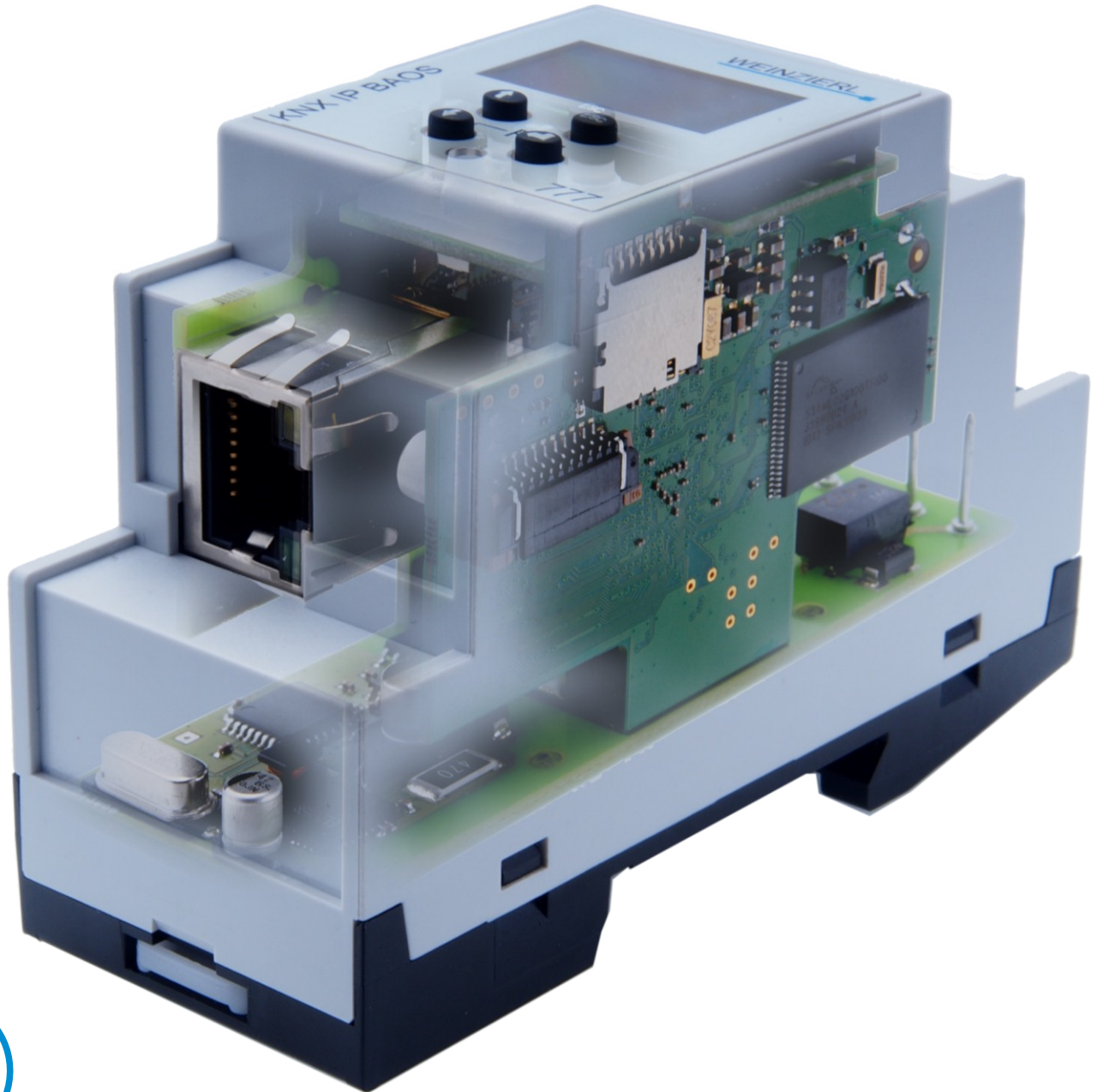

Timer with astro function

The KNX IP BAOS 777 includes a comprehensive time switch (timer) with adjustable weekdays.

In addition to fixed switching times, the new astrotimer enables variable switching times which adapt to sunrise or sunset over the course of the year. This increases comfort, for example when controlling blinds, and reduces costs, e.g. for outdoor lighting.

Web services

For developers the device supports RESTful web services with up to 2000 data points. Thus the KNX IP BAOS 777 is an universal residential gateway for many use cases in building control.

KNX Gateways

KNX DMX Gateway 544

The KNX DMX Gateway 544 is a compact gateway between KNX and DMX512 (protocol for lighting control) with up to 64 freely configurable channels. In master mode, the device allows convenient control of DMX lights. Up to 64 dimming channels or up to 8 RGB/RGBW channels are available. In slave mode KNX actuators can be controlled by DMX. Up to 64 DMX512 addresses can be individually evaluated and sent to KNX. Dimming value, switching with switching threshold and RGB value are available for interpretation.



KNX Modbus TCP Gateway 716

The KNX Modbus TCP Gateway 716 is a compact gateway between KNX TP and Modbus TCP with 250 freely configurable data points. The device enables easy integration of Modbus devices that support the TCP protocol via IP and can act as a Modbus master or slave. As Master the device can address up to 5 slave devices. Two buttons and three LEDs allow local operation and visualization of the device status. Furthermore, the device can be used as a programming interface to connect one or more PCs to the KNX bus (e.g. for ETS®). The power is supplied via the KNX bus. The configuration can additionally be exported and imported by a DCA (Device Configuration App, SW extension in the ETS).

KNX Modbus RTU Gateway 886.1 secure

The KNX Modbus RTU Gateway 886.1 *secure* allows an easy integration of Modbus devices which support the RTU protocol on RS-485 and can act as a Modbus master or slave. The assignment between KNX objects and Modbus registers can be configured via parameters in the ETS. The configuration can additionally be exported and imported by a DCA (Device Configuration App, SW extension in the ETS).

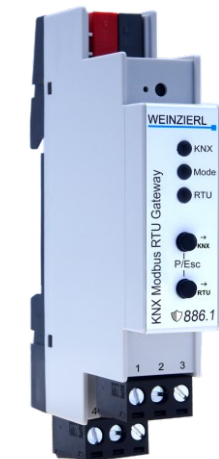

Revox Multiuser 3.0 KNX Gateway by Weinzierl

With the Revox Multiuser 3.0 KNX gateway, the Revox Multiuser system can be conveniently integrated into the KNX home control system. The gateway serves as an interface between the Revox Multiuser system and KNX. Most of the available functions are controlled with a simple 1-bit command and corresponding status feedback is available for the basic functions. For example, switching on the TV set can activate the Multiuser amplifier M30 with the corresponding input and simultaneously start a light / blind scene in the KNX world.

KNX Gateways: Modbus, DMX

KNX DMX Gateway 544 - KNX gateway to DMX512



Compact gateway between KNX and DMX512 with up to 64 freely configurable channels. Master mode (KNX to DMX luminaires) and slave mode (DMX control to KNX actuators).

- Assignment between KNX and DMX512 via ETS® parameters
- Master: up to 64 individual dimming channels or up to 8 RGB/RGBW channels
- Slave: up to 64 DMX addresses evaluated individually
- 4 sequencers for complex time sequences
- Status display via 3 LEDs
- Connections: KNX, plugable screw terminals for DMX512, power supply
- For DIN rail, width 1 unit (18 mm)

KNX DMX Gateway 544

Art. no. 5358 Gross price* 308.70 €

KNX Modbus TCP Gateway 716 secure - KNX gateway to modbus TCP



Compact KNX / modbus gateway with 250 freely configurable channels (KNX data points). The device allows easy integration of modbus devices supporting the TCP protocol via LAN into KNX installations. It can be used as modbus master or slave. The assignment between KNX objects and modbus registers is done via parameters in the ETS® - no further tool is required. Furthermore, the device can be used as a programming interface to connect one or more PCs to the KNX bus (e.g. for ETS®). Power is supplied via the KNX bus. The device supports KNX Security.

- KNXnet/IP tunneling, 8 tunnel connections
- Support of KNX Long Frames
- Modbus master or slave mode
- Assignment between KNX and modbus via ETS® parameters
- As master: up to 5 slave devices
- 250 data points
- Support of KNX Security
- Status display via 3 LEDs
- Power supply via KNX bus
- Connections: KNX, LAN RJ-45
- For DIN rail, width 1 unit (18 mm)

KNX Modbus TCP Gateway 716 secure

Art. no. 5425 Gross price* 398.00 €

KNX Modbus RTU Gateway 886.1 secure - KNX gateway to modbus RTU



Compact KNX / modbus gateway with 250 freely configurable channels (KNX data points). The device allows easy integration of modbus devices supporting the RTU protocol via RS-485 into KNX installations. It can be used as modbus master or slave. The assignment between KNX objects and modbus registers is done via parameters in the ETS® - no further tool is required.

- Support of KNX Security
- Modbus master or slave mode
- Assignment between KNX and modbus via ETS® parameters
- Master mode: up to 25 slave devices
- 250 data points
- Status display via 3 LEDs
- Connections: KNX, plugable screw terminals for modbus, power supply
- For DIN rail, width 1 unit (18 mm)

KNX Modbus RTU Gateway 886.1 secure

Art. no. 5498 Gross price* 358.40 €

Revox Multiuser 3.0 KNX Gateway by Weinzierl - Interface between the Revox Multiuser System and the KNX world



With the Revox Multiuser 3.0 KNX gateway, the Revox Multiuser System can be conveniently integrated into the KNX home control system. The gateway serves as an interface between the Revox Multiuser system and KNX.

- Revox sound system connection
- KNXnet/IP tunnelling, 5 tunnel connections
- Status displays via 3 LEDs
- Power supply via KNX bus
- Connections: KNX, LAN RJ-45
- For DIN rail, width 1 TE (18 mm)

Revox Multiuser 3.0 KNX Gateway by Weinzierl

Purchase only via Revox

MATCH 55 push button series

MATCH 55 - it simply fits

With a rocker size of 55 x 55 mm the MATCH 55 series products KNX RF / ENO Push Button 440 *secure* and KNX TP Push Button 420.1 *secure* fit perfectly to numerous frame series and sockets available on the market. Both are available as single or double rocker with a gentle and quiet keystroke which is ideal for their installation in bedrooms and living rooms.



Fusion - our design favorite

Our MATCH 55 Push Button Inserts are compatible with many frames of different manufacturers supporting a 55 mm design range. Nevertheless, in our portfolio we offer the design series 'Fusion' in two colors and two materials including real glass. Fusion is a frame design of the brand Opus® by Jäger Direkt, Germany. For more information please contact Jäger Direkt / Jäger Fischer GmbH & Co. KG.

KNX RF / ENO Push Button 440 *secure*

Wireless switches are required if a cable is no option. Due to the flat mechanic design the new RF push button can be mounted on the surface e.g. on walls of glass. The KNX RF / ENO Push Button 440 *secure* unites two wireless protocols in one device: EnOcean and KNX RF. Out of the box the push button operates in EnOcean mode. EnOcean *secure* mode can be enabled via pressing a key combination. By configuration with the ETS® the push button switches to KNX RF mode with optional support of KNX security. Via a factory reset the device can be switched back to EnOcean protocol.

EnOcean with battery

EnOcean is a well-tried standard mainly known for self-powered devices. Batteryless push buttons are an interesting solution but also having some drawbacks like required force and noise. To overcome this our RF push button insert uses a battery to achieve a soft and quiet user experience. The gentle and quiet push-button action enables installation in bedrooms and living rooms. The KNX RF / ENO Push Button 440 *secure* is operated by a battery of type CR2032. The typical life time of the battery is five years. The push button insert running in EnOcean mode can be used in any EnOcean installation. It can also be integrated into a KNX network using our KNX ENO gateways, for e.g. KNX ENO 626 *secure*.

Easy installation and operation

KNX RF combines the flexibility of wireless devices with the proven quality of the KNX standard. Pressing a button can be much more than switching a light. Commissioning with the ETS allows nearly unlimited functionality like calling a scene, setting a RGB color or driving a shutter in the way you like it. KNX RF devices can seamlessly be integrated in KNX TP networks with our new KNX RF/TP Coupler 673.1 *secure*.

Commissioning via RF or USB

Like all KNX devices, our wireless push-button can also be programmed via the KNX network. The ETS can be connected via a dedicated KNX USB interface for RF or via a TP interface and a KNX RF/TP media coupler. The integrated USB interface in the wireless push-button can be used for direct programming of the device via the ETS, but also enables wireless programming of other KNX RF devices.

KNX TP Push Button 420 *secure*

The TP version of our push button has an integrated bus coupler for the KNX bus. The flat design allows mounting even on wall boxes with reduced space. Furthermore, the device includes a sequencer and supports ten independent logic or timer functions. The device is also available as push button interface. This variant does not include rockers and mounting frames but interface wires to connect standard switches with dry contacts. So you can use the same powerful application also for other switches or contacts. The built-in switches allow a fast testing of the configuration.

The push button interface

The device can be used with one or two rockers or as a push button interface and offers four independent button functions. Six multi-colored LEDs enable the display of different statuses, provided the rockers used support this.

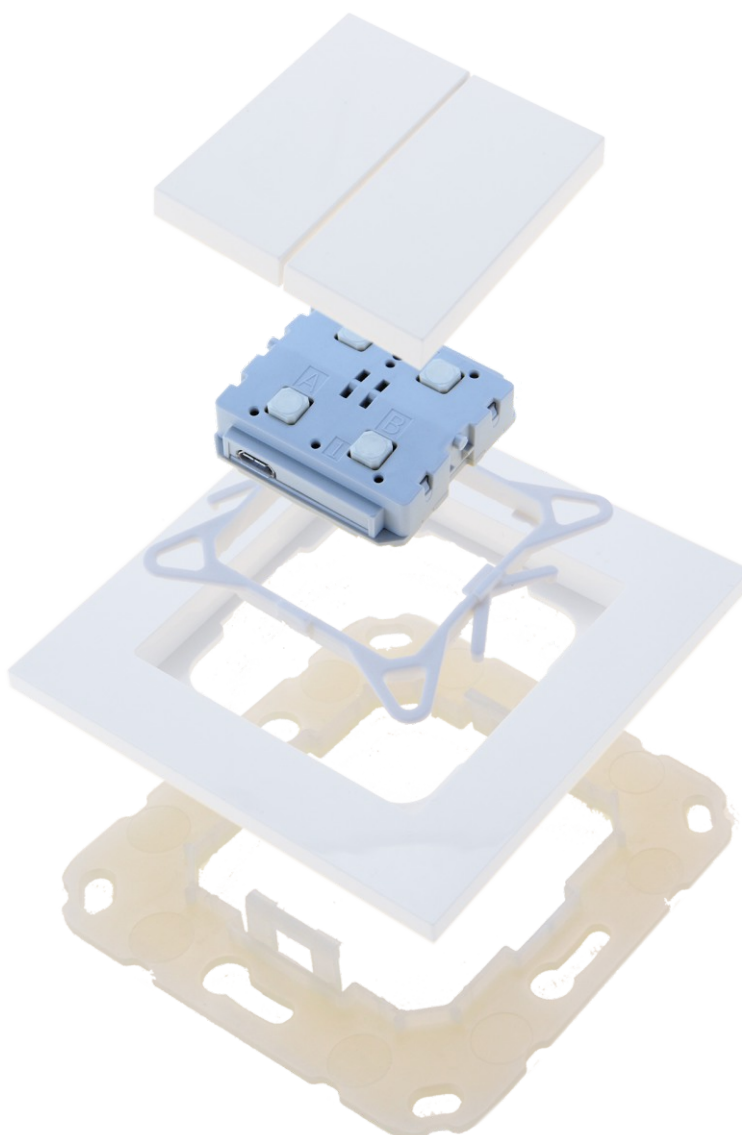

Push it

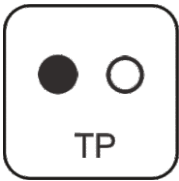

KNX TP Push Button 420.1 *secure*

The KNX TP Push Button 420.1 *secure* is the new generation of our KNX push buttons from the MATCH 55 series. Both the hardware and the ETS application have been significantly enhanced.

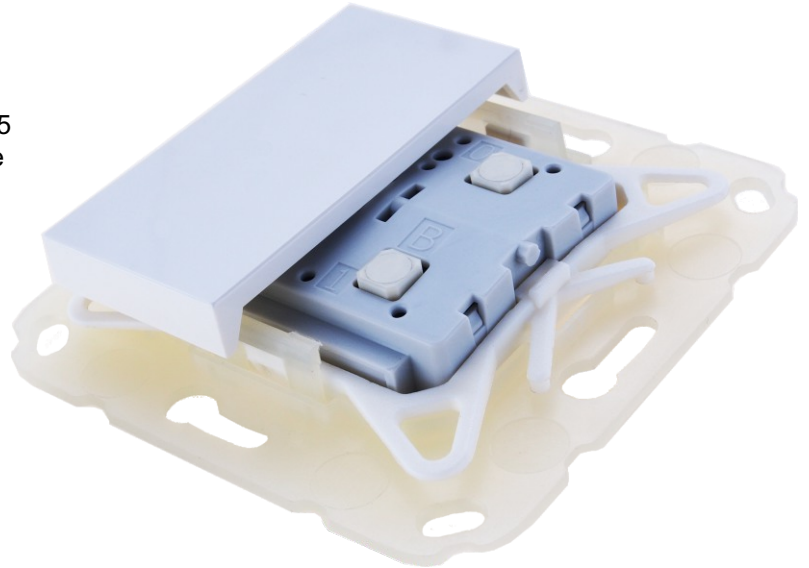

Extensive functions

The device is part of the MATCH 55 push button series. The application offers extensive functions for switching, dimming, blinds, value transmitters, scene and colour control as well as a sequence controller and a room temperature controller.



LED status display

The new push button has six two color LEDs (blue/red), which can be freely parameterized. Four LEDs are provided for the double rockers, two are located in the middle for single rockers.

Acoustic signal

The KNX TP Push Button 420.1 *secure* also has an acoustic signal. Various sound sequences can be called up via communication objects. This enables, for example, a discreet doorbell in individual rooms.

Room temperature controller

The integrated temperature sensor with controller function is an extension. The room temperature controller is not only suitable for individual room heating control, but also for air conditioning systems and cooling ceilings. It can be operated via a visualization system such as the KNX IP BAOS 777 with web interface.

MATCH 55 push button series

KNX TP Push Button 420 *secure* with single rocker - KNX push button MATCH 55 series KNX TP Push Button 420 *secure* with double rocker - KNX push button MATCH 55 series

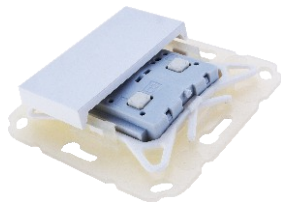

KNX push button of the MATCH 55 series, with integrated bus coupling unit. The push button insert fits numerous switch ranges available on the market with 55 mm internal dimensions. Soft and quiet push-button action. Optional support of KNX Security.

- Pleasantly soft and quiet pressure point
- Support of KNX Security
- Powerful KNX application for switching, dimming and shutters
- Functions for scenes, sequences and RGB control
- Mounting kit included (without design frame)
- Rockers for standard frames with internal dimensions 55 x 55 mm
- Dimensions wall mounting plate: 71 x 71 mm, for flush mounted box 68 mm

KNX TP Push Button 420 *secure*: Single rocker
KNX TP Push Button 420 *secure*: Double rocker

Art. no. 5375 Gross price* 83.10 €
Art. no. 5325 Gross price* 88.40 €

KNX TP Push Button 420.1 *secure* - KNX push button MATCH 55 series with integrated room temperature controller



KNX push button from the MATCH 55 series with integrated room temperature controller. The push button is suitable for numerous switch ranges available on the market with 55 mm internal dimensions. Soft and quiet push button action. Optional support of KNX Security.

- Integrated KNX bus coupler
- Temperature sensor with controller function
- Six duo color LEDs blue/red (4 for double rocker, 2 for single rocker)
- Acoustic signal transmitter (multi tone beeper)
- Powerful KNX application for switching, dimming and shutters
- Comfort functions for scenes, sequences and RGB control
- Support of KNX Security
- Pleasantly soft and quiet pressure point

KNX TP Push Button 420.1 *secure*

Art.-Nr. 5492 Gross price* On request

Note: Single and double rockers can be found on our homepage

KNX TP Push Button Interface 420 *secure* - KNX push button interface 4-fold



Push button interface for the KNX bus for the connection of up to four conventional push buttons or dry contacts. In addition, the device offers two outputs for LEDs. Optional support of KNX Security.

- Support of KNX Security
- Powerful KNX application for switching, dimming and shutters
- Functions for scenes, sequences and RGB control
- Including plugable connection cable 150 mm
- Connections: KNX, 4-fold binary input, 2 ext. LEDs
- Dimensions without bus terminal (LxWxH): 40 x 40 x 11 mm

KNX TP Push Button Interface 420 *secure*

Art. no. 5385 Gross price* 79.90 €

24V Push Button 436 with single rocker - Potential free push button MATCH 55 series 24V Push Button 436 with double rocker - Potential free push button MATCH 55 series



Push button for extra low voltage of the MATCH 55 series, for direct connection to push button inputs of, for example, smart home control centers, PLC controls or push button interfaces of any bus systems. The optional terminal block enables the screwless connection of cables with a cross section of up to 0.75 mm².

- Pleasantly soft and quiet pressure point
- Mounting kit included (without design frame)
- Connections: plugable connection cable 150 mm
- Rockers for standard frames with internal dimensions 55 x 55 mm
- Dimensions wall mounting plate: 71 x 71 mm, for flush mounted box 68 mm

24V Push Button 436: Single rocker
24V Push Button 436: Double rocker
Terminal block for 436

Art. no. 5409 Gross price* 50.80 €
Art. no. 5410 Gross price* 52.90 €
Art. no. 5413 Gross price* 23.40 €

MATCH 55 push button series

KNX RF / ENO Push Button 440 secure with single rocker - KNX push button MATCH 55 series
KNX RF / ENO Push Button 440 secure with double rocker - KNX push button MATCH 55 series

KNX wireless push button of the MATCH 55 series, with integrated bus coupling unit. The wireless push button offers support for EnOcean and KNX RF in one device. The device works in EnOcean mode without configuration (EnOcean Security is activated by a simple push button combination). By configuration with ETS® the push button switches to KNX RF mode and offers optional support of KNX Security.

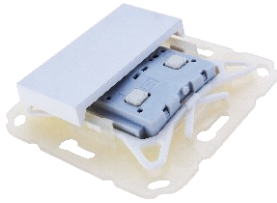

- Pleasantly soft and quiet pressure point
- EnOcean 868.3 MHz, ASK, EEP F6-02-01 / -03
- Support of EnOcean Security
- KNX RF 868.3 MHz, FSK, S-Mode
- Support of KNX Security
- Powerful KNX application for switching, dimming and shutters
- Functions for scenes, sequences and RGB control
- Integrated interface USB to KNX RF
- Mounting kit included (without design frame)
- Connectors: USB Type Micro B, internal antenna
- Power supply via battery type CR2032
- Rockers for standard frames with internal dimensions 55 x 55 mm
- Dimensions wall mounting plate: 71 x 71 mm, for flush mounted box 68 mm
- Recommended for EnOcean gateways, on page 13 and RF / TP on page 27

KNX RF / ENO Push Button 440 secure: Single rocker
KNX RF / ENO Push Button 440 secure: Double rocker

Art. no. 5374	Gross price*	99.10 €
Art. no. 5326	Gross price*	104.90 €

Frame Fusion 1-fold white - Frame for MATCH 55 series
Frame Fusion 1-fold anthracite - Frame for MATCH 55 series



Standard frame for MATCH 55 series (frame only).

- Budget solution for push button installations
- Available in two colors
- Dimensions (LxWxH): 85 x 85 x 11 mm

Frame 1-fold Fusion: white
Frame 1-fold Fusion: anthracite

Art. no. 5386	Gross price*	3.95 €
Art. no. 5387	Gross price*	6.85 €

Glass frame Fusion 1-fold white - Frame for MATCH 55 series
Glass frame Fusion 1-fold black - Frame for MATCH 55 series



Glass frame for MATCH 55 series (frame only).

- Design solution for push button installations
- Available in two colors
- Dimensions (LxWxH): 85 x 85 x 11 mm

Glass frame 1-fold Fusion: white
Glass frame 1-fold Fusion: black

Art. no. 5388	Gross price*	39.80 €
Art. no. 5389	Gross price*	41.10 €

Note: Single and double rockers can be found on our homepage

KNX wireless

Direct link to ETS

For a direct link from ETS to KNX RF our KNX RF USB Interface Stick 340 is available. It can be connected directly to a PC or laptop. The RF interface can be selected in the connection manager of ETS.



Simple installation with ETS

To link wireless KNX devices to Twisted Pair media coupler are available from Weinzierl. These also support the Segment Coupler function. Similar to line coupler each media coupler opens a new so-called domain similar to a line on TP. So with KNX and ETS 5 you can install KNX networks with devices connected to TP or IP together with wireless KNX devices. All within one system and one project. This reduces costs for installation, maintenance and last but not least for training on technology. In the new ETS 6 it is possible to extend a KNX TP line directly with KNX RF devices using the so-called KNX Segment Coupler. This is possible with our new KNX RF/TP Coupler 673.1 *secure*.

Wireless KNX

KNX RF (radio frequency) is the wireless variant in the KNX standard. This is particularly recommended in places that are not suitable for wiring. Here are especially modern installation situations, such as the installation of push buttons on glass walls.

Starting with ETS 5, KNX RF devices can be configured in the same professional way as KNX TP devices.

The configuration of KNX RF devices and KNX TP devices is identical starting with ETS 5. There are no differences in parameters or individual address. Unique for a KNX RF line is the additional domain address, which is automatically created by the ETS.

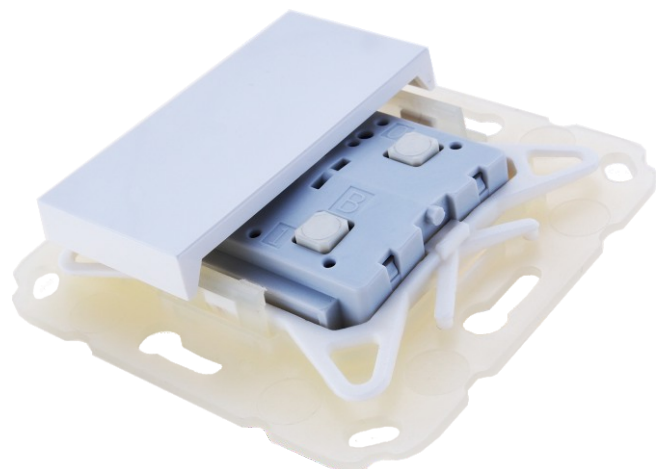

KNX RF

KNX RF USB Interface Stick 340 - KNX USB interface for RF



USB stick as interface to KNX RF. The device can be used as a programming interface for the ETS® software (ETS 5 or higher).

- Support of KNX Long Frames
- Support of Weinzierl BAOS Protocol V2
- Connectors: USB type A, internal antenna
- Dimensions (LxWxH): 71 x 23 x 8.7 mm

KNX RF USB Interface Stick 340

Art. no. 5110 Gross price* 184.40 €

KNX RF/TP Coupler 673.1 *secure* - KNX media coupler for RF



KNX radio coupler in compact design (flush mounted housing). Support of KNX Security. The coupler connects KNX RF devices of a radio line with the KNX bus twisted pair. For KNX installations with ETS®.

- For the connection of KNX RF with KNX TP
- For KNX S-Mode (ETS)
- Support of KNX Security
- Support of KNX Long Frames
- Support of KNX Security Proxy
- Support of Segment Coupler
- Connections: KNX, internal antenna
- Compact flush mounted housing

KNX RF/TP Coupler 673.1 *secure*

Art. no. 5474 Gross price* 238.30 €

KNX RF / ENO Push Button 440 *secure* with single rocker - KNX push button MATCH 55 series

KNX RF / ENO Push Button 440 *secure* with double rocker - KNX push button MATCH 55 series

KNX wireless push button of the MATCH 55 series, with integrated bus coupling unit. The wireless push button offers support for EnOcean and KNX RF in one device. The device works in EnOcean mode without configuration (EnOcean Security is activated by a simple push button combination). By configuration with ETS® the push button switches to KNX RF mode and offers optional support of KNX Security.

- Pleasantly soft and quiet pressure point
- EnOcean 868.3 MHz, ASK, EEP F6-02-01 / -03
- Support of EnOcean Security
- KNX RF 868.3 MHz, FSK, S-Mode
- Support of KNX Security
- Powerful KNX application for switching, dimming and shutters
- Functions for scenes, sequences and RGB control
- Integrated interface USB to KNX RF
- Mounting kit included (without design frame)
- Connectors: USB type Micro B, internal antenna
- Power supply via battery type CR2032
- Rockers for standard frames with internal dimensions 55 x 55 mm
- Dimensions wall mounting plate: 71 x 71 mm, for flush mounted box 68 mm
- Recommended for EnOcean gateways, on page 13

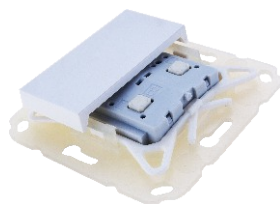

KNX RF / ENO Push Button 440 *secure*: Single rocker
KNX RF / ENO Push Button 440 *secure*: Double rocker

Art. no. 5374 Gross price* 99.10 €
Art. no. 5326 Gross price* 104.90 €

Segment Coupler

New flexibility with KNX Segment Coupler

The segment coupler functionality is a new extension of our KNX RF/TP Coupler 673.1 *secure*. This feature allows connecting the RF/TP coupler within a TP Line. It bypasses the legacy requirement to connect the coupler only at the level of an area or backbone. In addition it enables the usage of RF segments in installation with IP backbone. This was not possible without it. ETS® supports the segment coupler starting with ETS 6 and loads the filter tables according to the topology of the project.



Linking Secure and Unsecure via Security Proxy

Today many devices for KNX TP do not yet support security. While for the wired part this often is acceptable, security is a must for an open medium like KNX RF. The missing link now is closed with a new feature in the KNX system called Security Proxy. It is an extension which we have implemented in our KNX RF/TP Coupler 673.1 *secure*. Via this feature the device is able to decrypt secured KNX telegrams on RF and forward them as unsecure telegrams to the KNX bus and vice-versa. The group addresses remain unchanged during translation. The Secure Proxy was introduced in ETS together with the Segment Coupler. It loads the mapping and key tables according to the links set in the ETS project.

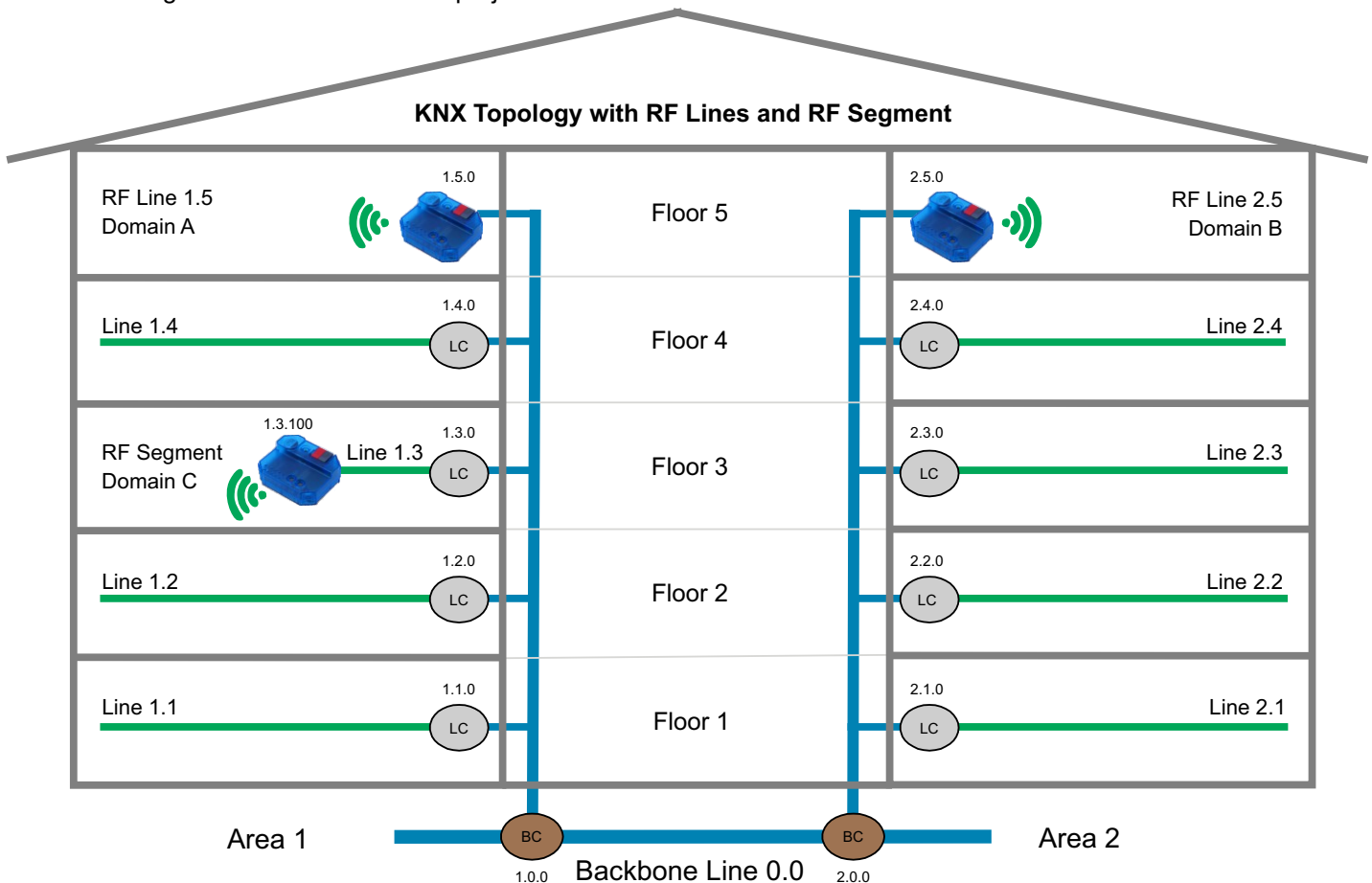

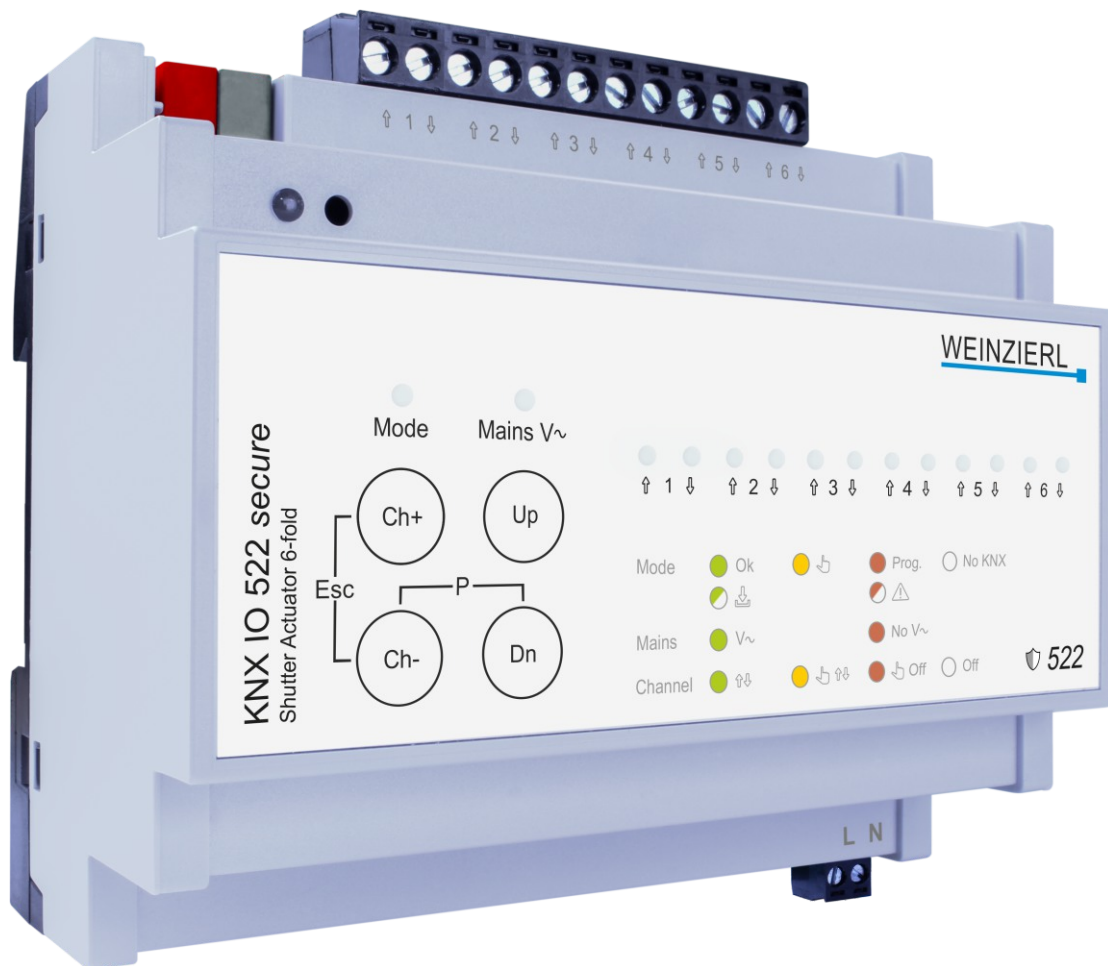

WEINZIERL ENGINEERING GmbH

Achatz 3-4
84508 Burgkirchen an der Alz
GERMANY
Tel.: +49 8677 / 916 36 - 0
E-Mail: info@weinzierl.de
Web: www.weinzierl.de